

SCD8669

2.5A ULDO Adjustable Positive Voltage Regulator

VRG8669

Features

- Manufactured using Linear Technologies Space Qualified RH3083 die
- Radiation performance
 - Total dose: 100 krad(Si), Dose rate = 50 rad(Si)/s
 - ELDRS: 100 krad(Si), Dose rate \leq 0.01 rad(Si)/s
- Current Limit with Foldback and Over-temperature protection
- Input voltage range: 1.2V to 23V
- Output voltage adjustable: 0V to 18V
- Outputs may be paralleled for higher current
- Post irradiated Dropout voltage @ +25°C, $V_{CONTROL} \geq 2$ Volts:
 - 0.66V @ 2.5Amps
 - 0.225V @ 1.0Amps
- Output current: 2.5Amps
- Packaging – Hermetic Ceramic
 - Hermetic Surface Mount Power
 - 5 Pads, .550"L x .301"W x .127"Ht
 - Weight - 2.0 gm max
- Designed for aerospace and high reliability space applications
- **Radiation Hardness Assurance Plan: DLA Certified to MIL-PRF-38534, Appendix G.**

Description

The VRG8669 consists of a Positive Adjustable (RH3083) ULDO voltage regulator capable of supplying 2.5Amps over the output voltage range as defined under recommended operating conditions. The VRG8669 offers excellent line and load regulation specifications and ripple rejection. Dropout ($V_{IN} - V_{OUT}$) decreases at lower load currents.

The VRG8669 serves a wide variety of applications including SCSI-2 Active Terminator, High Efficiency Linear Regulators, Post Regulators for Switching Supplies, Constant Current Regulators, Battery Chargers and Microprocessor Supply.

The VRG8669 has been specifically designed to meet exposure to radiation environments and is configured for an SMD power package. It is guaranteed operational with a case operating temperature from -55°C to +125°C. Available screened to MIL-STD-883, the VRG8669 is ideal for demanding military and space applications.

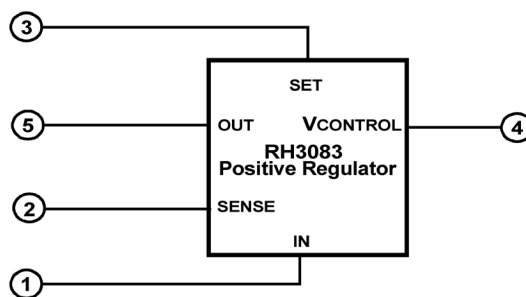

Figure 1 - Block Diagram / Schematic

SCD8669

2.5A ULDO Adjustable Positive Voltage Regulator

VRG8669

Absolute Maximum Ratings

Parameter (Voltages are Relative to V_{OUT})	Rating	Units
Input Voltage	+18, -0.3	V_{DC}
Input Voltage (No Overload or Short Circuit)	+23, -0.3	V_{DC}
$V_{CONTROL}$	± 28	V_{DC}
SET Pin Current	± 25	mA
SET Pin Voltage	± 10	V_{DC}
Output Short Circuit Duration	Indefinite	-
Lead temperature (soldering 10 Sec)	300	$^{\circ}C$
ESD <u>1</u>	2,000 - 3,999	V
Operating Junction Temperature Range	-55 to +150	$^{\circ}C$
Storage Temperature Range	-65 to +150	$^{\circ}C$
Thermal Resistance (Junction to Case) Θ_{JC}	2.5	$^{\circ}C/W$

1 / Meets ESD testing per MIL-STD-883, method 3015, Class 2.

Notice: Stresses above those listed under "Absolute Maximum Ratings" may cause permanent damage to the device. These are stress rating only; functional operation beyond the "Operation Conditions" is not recommended and extended exposure beyond the "Operation Conditions" may affect device reliability.

Recommended Operating Conditions

Parameter	Range	Units
Input Voltage (Voltages are Relative to V_{OUT})	1 to 23	V_{DC}
$V_{CONTROL}$ (Voltages are Relative to V_{OUT})	1.6 to 25	V_{DC}
Input Output Differential	0.5 to 18	V_{DC}
Case Operating Temperature Range	-55 to +125	$^{\circ}C$

SCD8669

2.5A ULDO Adjustable Positive Voltage Regulator

VRG8669

Electrical Performance Characteristics

Unless otherwise specified: $-55^{\circ}\text{C} \leq T_C \leq +125^{\circ}\text{C}$.

Parameter	Symbol	Conditions ($P \leq P_{MAX}$)	TEMP	MIN	MAX	Units
Set Pin Current	I_{REF}	$V_{IN} = 2V, V_{CONTROL} = 3V, V_{OUT} = 1V$ $1\text{ mA} \leq I_{LOAD} \leq 2.5A,$ <u>2/</u>	All	49.0	51.5	μA
		$V_{IN} = 1V, V_{CONTROL} = 2V, I_{LOAD} = 1\text{mA}$ <u>1/ 3/ 4/</u>	25°C	49	51	
Output Offset Voltage ($V_{OUT} - V_{SET}$)	V_{OS}	$V_{IN} = 2V, V_{CONTROL} = 3V, V_{OUT} = 1V, I_{LOAD} = 1\text{mA}$ <u>2/</u>	All	-6.0	6.0	mV
		$V_{IN} = 1V, V_{CONTROL} = 2V, I_{LOAD} = 1\text{mA}$ <u>1/ 3/ 4/</u>	25°C	-4.5	4.5	
Line Regulation	ΔV_{OS}	$2V \leq V_{IN} \leq 24V, 3V \leq V_{CONTROL} \leq 26V, V_{OUT} = 1V, I_{LOAD} = 1\text{mA}$ <u>2/</u>	25°C	-0.07	0.07	mV/V
		$2V \leq V_{IN} \leq 24V, 3V \leq V_{CONTROL} \leq 26V, V_{OUT} = 1V, I_{LOAD} = 5\text{mA}$ <u>2/</u>	-55°C +125°C	-0.07	0.07	
		$1V \leq V_{IN} \leq 23V, 2V \leq V_{CONTROL} \leq 25V, I_{LOAD} = 1\text{mA}$ <u>1/ 3/ 4/</u>	25°C	-0.03	0.03	
Load Regulation	ΔV_{OS}	$V_{IN} = 2V, V_{CONTROL} = 3V, V_{OUT} = 1V,$ $I_{LOAD} = 5\text{mA to } 2.5A$ <u>2/</u>	All	-10.0	10.0	mV
		$I_{LOAD} = 5\text{mA to } 2.5A$ <u>1/ 3/ 4/</u>	25°C	-3.5	3.5	
$V_{CONTROL}$ Dropout Voltage <u>5/</u>	V_{CDROP}	$I_{LOAD} = 2.5A, V_{IN} = 2V$ <u>2/</u>	All	-	1.65	V
		$I_{LOAD} = 2.5A, V_{IN} = 1V$ <u>1/ 3/ 4/</u>	25°C	-	1.53	
		$I_{LOAD} = 1A, V_{IN} = 1V$ <u>1/ 3/ 4/</u>	25°C	-	1.48	
V_{IN} Dropout Voltage <u>5/</u>	V_{INDROP}	$I_{LOAD} = 2.5A, V_{CONTROL} = 3V$ <u>2/</u>	All	-	0.75	V
		$I_{LOAD} = 2.5A, V_{CONTROL} = 2V$ <u>1/ 3/ 4/</u>	25°C	-	0.66	
		$I_{LOAD} = 1.0A, V_{CONTROL} = 2V$ <u>1/ 3/ 4/</u>	25°C		0.225	
Current Limit	I_{MAX}	$V_{IN} = V_{CONTROL} = +5V, V_{OUT} = 1V, 30\text{msec pulsed } \underline{2/ 6/}$	25°C	2.8	-	A
		$V_{IN} = V_{CONTROL} = +5V, V_{SET} = 0V, V_{OUT} = -0.1V \underline{1/ 3/ 4/}$	25°C			
Minimum Load Current <u>1/ 3/ 4/</u>	I_{MIN}	$V_{CONTROL} = 25V, V_{IN} = 23V$	All	-	1.0	mA
Ripple Rejection <u>2/</u>	-	$V_{IN} = 13V, V_{OUT} = 10V, V_{CONTROL} = 3V, V_{AC} = 1V_{P-P},$ $I_{LOAD} = 0.2A, f = 120\text{Hz}, C_{OUT} = 10\mu\text{F}, C_{SET} = 0.1\mu\text{F}$	All	60	-	dB

SCD8669

2.5A ULDO Adjustable Positive Voltage Regulator

VRG8669

Notes:

- 1) Specification reflects Total Dose exposure to 100 krad(Si) @+25°C.
- 2) Production test conditions: V_{IN} and $V_{CONTROL}$ are the supply voltages applied during testing, referenced to ground.
- 3) Irradiation test conditions: V_{IN} and $V_{CONTROL}$ are relative to V_{OUT} . See the Linear Technology (RH3083) datasheet for +25°C limits to determine deviations due to irradiation.
- 4) Not production tested. Shall be guaranteed by design, characterization, or correlation to other tested parameters.
- 5) Dropout results from either minimum control voltage, $V_{CONTROL}$, or minimum input voltage, V_{IN} , both specified with respect to V_{OUT} . These specifications represent the minimum input-to-output differential voltage required to maintain regulation.
- 6) Pulsed @ <10% duty cycle @ +25°C for characterization only.

VRG8669

Figure 2 - Maximum Power vs Case Temperature

The maximum Power dissipation is limited by the thermal shutdown function of the regulator chip in the VRG8669. The graph above represents the achievable power before the chip shuts down. The line in the graph represents the maximum power dissipation of the VRG8669. This graph is based on the maximum junction temperature of 150°C and a thermal resistance (Θ_{JC}) of 2.5°C/W.

SCD8669

2.5A ULDO Adjustable Positive Voltage Regulator

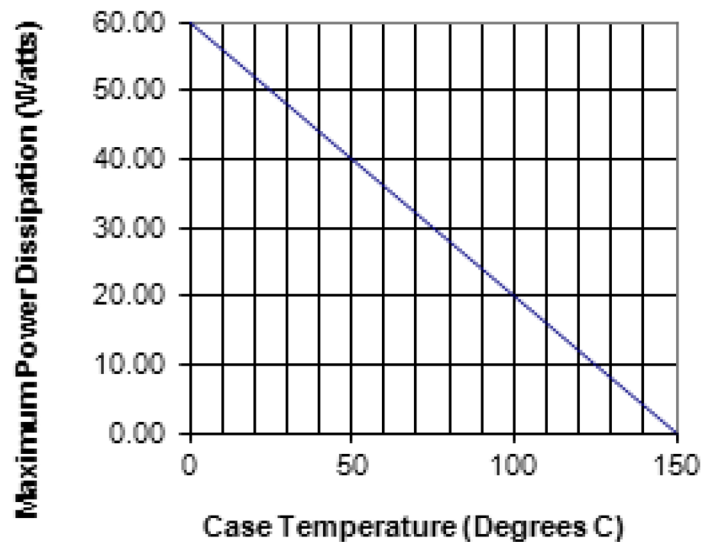
VRG8669

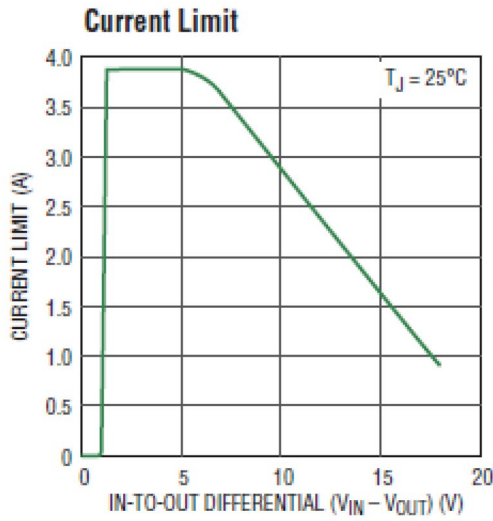

Figure 3 - RH3083 Typical Current Limit

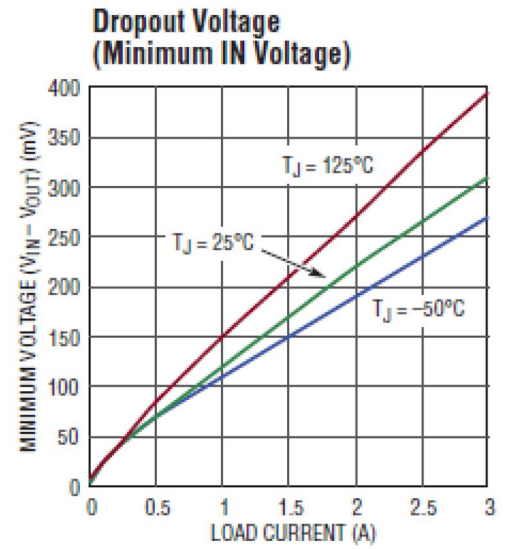

Figure 4 - RH3083 Typical Dropout Voltage Curve ($V_{CONTROL} \geq 1.6V$)

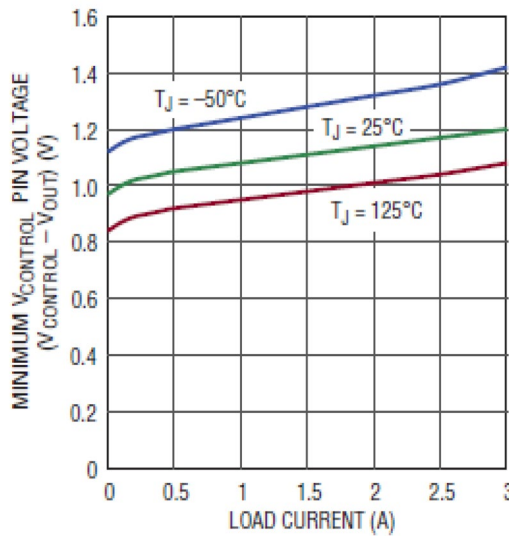

Figure 5 - RH3083 Typical $V_{CONTROL}$ Dropout

SCD8669

2.5A ULDO Adjustable Positive Voltage Regulator

VRG8669

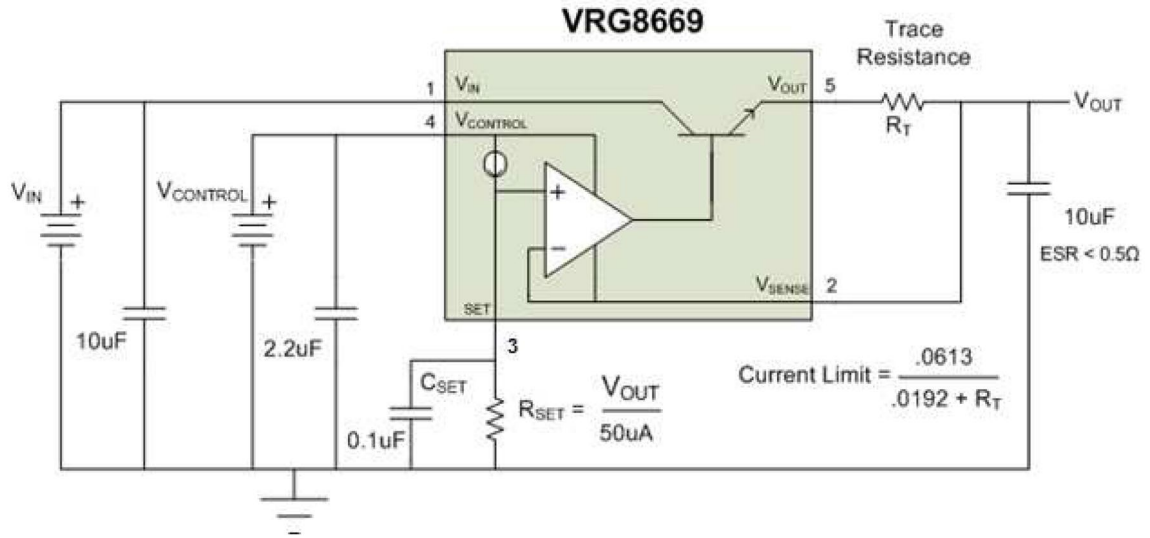

Figure 6 - Basic VRG8669 Adjustable Regulator Application

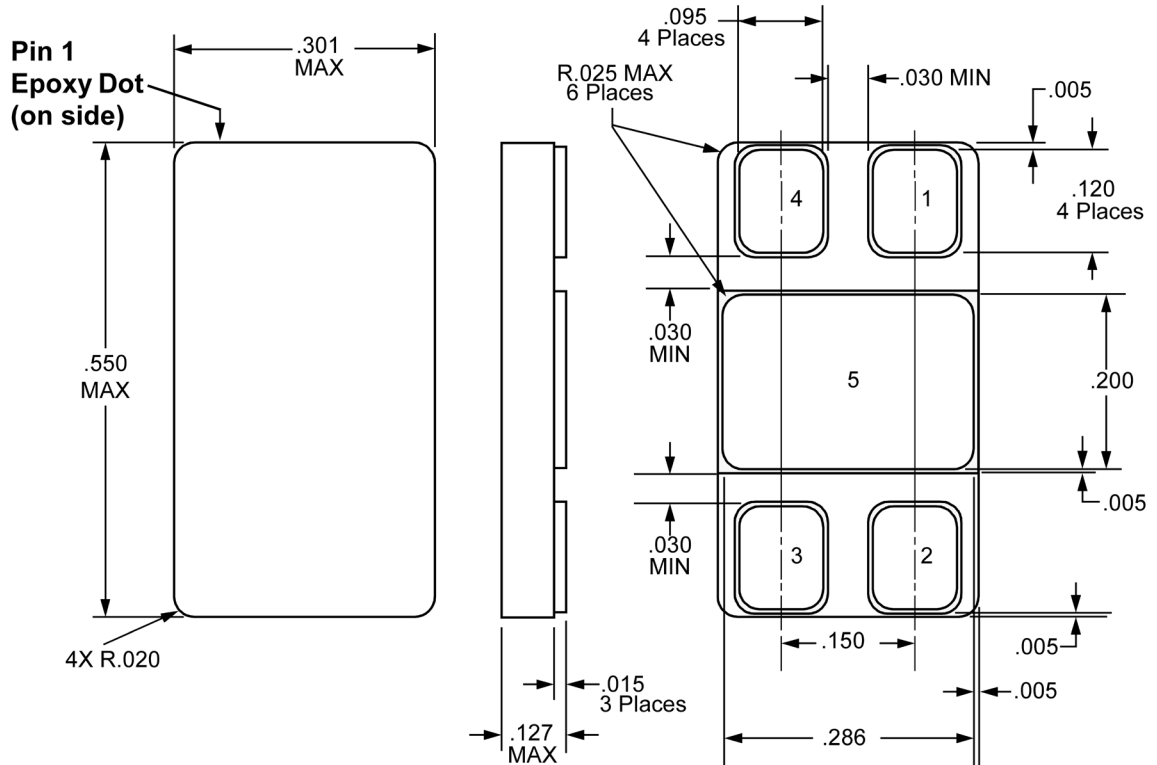

Figure 7 - Package Outline — Surface Mount

Note:

- 1) Package & Lid are electrically isolated from signal pads

SCD8669

2.5A ULDO Adjustable Positive Voltage Regulator

VRG8669

Ordering Information

Model	DLA SMD #	Screening	Package
VRG8669-7	-	Commercial Flow, +25°C testing only	SMD Power Pkg
VRG8669-S	-	Military Temperature, -55°C to +125°C Screened in accordance with the individual Test Methods of MIL-STD-883 for Space Applications	
VRG8669-901-1S	5962R1420101KYC	In accordance with DLA Certified RHA Program Plan to RHA Level "R", 100 krad(Si)	
VRG8669-901-2S	5962R1420101KYA		

Revision History

Date	Revision	Change Description
03/31/2016	G	Import into CAES format
06/21/2016	H	Add note 5/ to Load Regulation in the Electrical Performance Characteristics Table. Change Load Reg Iload to 1.0 to align with Note 5. Align Dimensions in Features with Package Outline.
11/2/2017	J	Change the heading from 'Released Datasheet' to 'Datasheet', Change the Features items to match LT publication for TID, ELDRS and Output, Revise the Absolute Max table, the Recommended table and the Electrical Performance Table to break out the irradiation conditions and apply the actual production test conditions. Update the Notes section.
02/18/2021	L	REVISED PER ECN 23515



SCD8669

2.5A ULDO Adjustable Positive Voltage Regulator

VRG8669

Datasheet Definitions

	DEFINITION
Advanced Datasheet	CAES reserves the right to make changes to any products and services described herein at any time without notice. The product is still in the development stage and the datasheet is subject to change . Specifications can be TBD and the part package and pinout are not final .
Preliminary Datasheet	CAES reserves the right to make changes to any products and services described herein at any time without notice. The product is in the characterization stage and prototypes are available.
Datasheet	Product is in production and any changes to the product and services described herein will follow a formal customer notification process for form, fit or function changes.

The following United States (U.S.) Department of Commerce statement shall be applicable if these commodities, technology, or software are exported from the U.S.: These commodities, technology, or software were exported from the United States in accordance with the Export Administration Regulations. Diversion contrary to U.S. law is prohibited.

Cobham Long Island Inc. d/b/a CAES reserves the right to make changes to any products and services described herein at any time without notice. Consult an authorized sales representative to verify that the information in this data sheet is current before using this product. The company does not assume any responsibility or liability arising out of the application or use of any product or service described herein, except as expressly agreed to in writing; nor does the purchase, lease, or use of a product or service convey a license under any patent rights, copyrights, trademark rights, or any other of the intellectual rights of the company or of third parties.